

# Anwendungshinweis Pneumatik- Schlagschrauber



## 9012 MT



## Application Note Pneumatic Impact Wrench

## Notice d'utilisation Clé à chocs pneumatique

## Toepassingsaanwijzing Pneumatik- Slagmoersleutel

















	de	en	fr	nl
	HAZET Pneumatik-Schlagschrauber zum Anziehen und Lösen von Verschraubungen, besonders robuste Ausführung	HAZET Pneumatic Impact Wrench for loosening and tightening screw connections	Clé à chocs pneumatique de HAZET pour serrer et desserrer les vis, exécution robuste	HAZET Pneumatische slagschroevendraaiers voor het aandraaien en losdraaien van schroefverbindingen, zeer robuuste uitvoering.
	Beachten Sie unbedingt die beiliegenden Sicherheitsvorschriften für HAZET-Pneumatikwerkzeuge!	Please observe the enclosed safety instructions for the HAZET pneumatic tools!	Veillez respecter impérativement les consignes de sécurité pour les outils pneumatiques de HAZET !	Neem per se de bijgevoegde veiligheidsvoorschriften in acht voor pneumatische gereedschappen van HAZET!
	Empf. Drehmoment	Recommended torque	Couple recommandé	Aanbevolen moment
	Max. Drehmoment	Max. torque	Couple max.	Maximaal moment
	Max. Lösemoment	Max. loosening torque	Couple de desserrage max.	Maximaal los moment
	Max. Drehzahl/min.	Max. revolutions per minute	Vitesse à vide max. / min.	TPM max.
	Luftverbrauch	Air consumption	Consommation d'air	Lucht-verbruik
	Betriebsdruck	Working pressure	Pression de service	Werkdruk
	Pneumatischer Schlagschrauber, Kupplungsstecker Nennweite 7,2 * mit Aufkängehaken	Pneumatic Impact Wrench, Coupler plug, nominal size 7.2 * with suspension hook	Clé à chocs pneumatique, Raccord de taille nominale 7.2 * avec crochet de suspension	Pneumatische slagschroevendraaier, verbindingstekker, nominale breedte 7,2 * Hook

Ursprungssprache deutsch – original language: German – Langue d'origine: allemand - Oorspronkelijke taal Duits



9012 MT Schlagschrauber AH

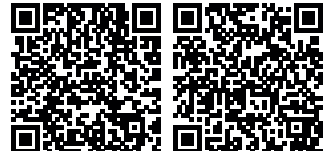
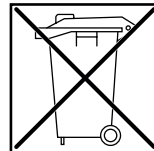
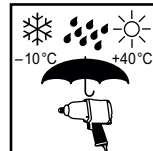
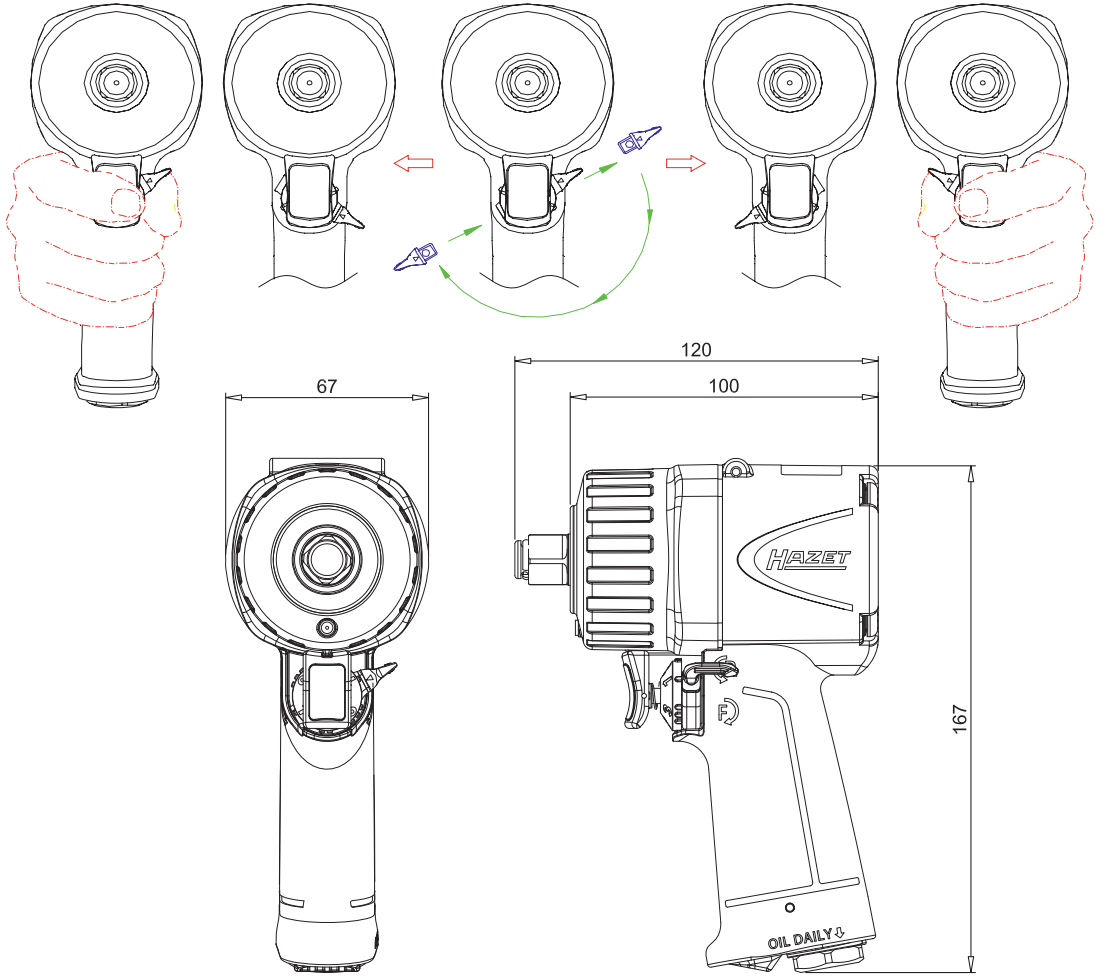

Technische Daten / Technical data / Informations techniques / Technische gegevens:

		M16
	m/s <sup>2</sup>	8.74
	dB(A)	Lp W 102 Lp A 92.7
	bar	6.3
	l/min.	135
	Ø mm	10
	kg	1.32
	1/min	9000
	Nm	1400
	Nm	745
	Nm	620
	Ø mm"	12,91 (1/2)  7,2
	mm"	12 1/2
<b>HAZET</b> No.		
	<b>9012</b> <b>MT</b>	



HAZET-WERK Hermann Zerver GmbH & Co. KG •  Güldenwerther Bahnhofstrasse 25-29 • 42857 REMSCHEID

 10 04 61 • 42804 REMSCHEID • GERMANY •  +49 (0) 21 91 / 7 92-0

 +49 (0) 21 91 / 7 92-375 (Deutschland) -400 (International) •  [www.hazet.de](http://www.hazet.de) •  [info@hazet.de](mailto:info@hazet.de)